



COMMONWEALTH OF PENNSYLVANIA  
DEPARTMENT OF ENVIRONMENTAL PROTECTION  
AIR QUALITY PROGRAM

STATE ONLY OPERATING PERMIT

Issue Date: May 20, 2019

Effective Date: June 1, 2019

Expiration Date: May 31, 2024

In accordance with the provisions of the Air Pollution Control Act, the Act of January 8, 1960, P.L. 2119, as amended, and 25 Pa. Code Chapter 127, the Owner, [and Operator if noted] (hereinafter referred to as permittee) identified below is authorized by the Department of Environmental Protection (Department) to operate the air emission source(s) more fully described in this permit. This Facility is subject to all terms and conditions specified in this permit. Nothing in this permit relieves the permittee from its obligations to comply with all applicable Federal, State and Local laws and regulations.

The regulatory or statutory authority for each permit condition is set forth in brackets. All terms and conditions in this permit are federally enforceable unless otherwise designated.

State Only Permit No: 67-05099

Federal Tax Id - Plant Code: 23-1689806-1

Owner Information

Name: KINSLEY CONST INC  
Mailing Address: 1110 E PRINCESS ST  
YORK, PA 17403-2543

Plant Information

Plant: KINSLEY CONST INC DBA KINSLEY MFG/YORK  
Location: 67 York County 67001 York City  
SIC Code: 3441 Manufacturing - Fabricated Structural Metal

Responsible Official

Name: ROBERT CHENAULT  
Title: VICE PRESIDENT  
Phone: (717) 815 - 6926

Permit Contact Person

Name: STEVE SNYDER  
Title: PLANT SUPERINTENDENT  
Phone: (717) 324 - 6114

[Signature] \_\_\_\_\_  
WILLIAM R. WEAVER, SOUTH CENTRAL REGION AIR PROGRAM MANAGER



## SECTION A. Table of Contents

### Section A. Facility/Source Identification

Table of Contents  
Site Inventory List

### Section B. General State Only Requirements

- #001 Definitions.
- #002 Operating Permit Duration.
- #003 Permit Renewal.
- #004 Operating Permit Fees under Subchapter I.
- #005 Transfer of Operating Permits.
- #006 Inspection and Entry.
- #007 Compliance Requirements.
- #008 Need to Halt or Reduce Activity Not a Defense.
- #009 Duty to Provide Information.
- #010 Revising an Operating Permit for Cause.
- #011 Operating Permit Modifications
- #012 Severability Clause.
- #013 De Minimis Emission Increases.
- #014 Operational Flexibility.
- #015 Reactivation
- #016 Health Risk-based Emission Standards and Operating Practice Requirements.
- #017 Circumvention.
- #018 Reporting Requirements.
- #019 Sampling, Testing and Monitoring Procedures.
- #020 Recordkeeping.
- #021 Property Rights.
- #022 Alternative Operating Scenarios.

### Section C. Site Level State Only Requirements

- C-I: Restrictions
- C-II: Testing Requirements
- C-III: Monitoring Requirements
- C-IV: Recordkeeping Requirements
- C-V: Reporting Requirements
- C-VI: Work Practice Standards
- C-VII: Additional Requirements
- C-VIII: Compliance Certification
- C-IX: Compliance Schedule

### Section D. Source Level State Only Requirements

- D-I: Restrictions
- D-II: Testing Requirements
- D-III: Monitoring Requirements
- D-IV: Recordkeeping Requirements
- D-V: Reporting Requirements
- D-VI: Work Practice Standards
- D-VII: Additional Requirements

Note: These same sub-sections are repeated for each source!

### Section E. Source Group Restrictions

- E-I: Restrictions
- E-II: Testing Requirements
- E-III: Monitoring Requirements



## **SECTION A. Table of Contents**

- E-IV: Recordkeeping Requirements
- E-V: Reporting Requirements
- E-VI: Work Practice Standards
- E-VII: Additional Requirements

### **Section F. Alternative Operating Scenario(s)**

- F-I: Restrictions
- F-II: Testing Requirements
- F-III: Monitoring Requirements
- F-IV: Recordkeeping Requirements
- F-V: Reporting Requirements
- F-VI: Work Practice Standards
- F-VII: Additional Requirements

### **Section G. Emission Restriction Summary**

### **Section H. Miscellaneous**

**SECTION A. Site Inventory List**

Source ID	Source Name	Capacity/Throughput	Fuel/Material
101	PORTABLE SPRAY PAINT UNIT 1	10.000 Lbs/HR	VOC
102	PORTABLE SPRAY PAINT UNIT 2	10.000 Lbs/HR	VOC
103	PORTABLE SPRAY PAINT UNIT 3	10.000 Lbs/HR	VOC
104	PORTABLE SPRAY PAINT UNIT 4	10.000 Lbs/HR	VOC
105	PORTABLE SPRAY PAINT UNIT 5	10.000 Lbs/HR	VOC
C100	DRY PANEL FILTER (SECTION 1)		
C200	DRY PANEL FILTER (SECTION 2)		
C300	DRY PANEL FILTER (SECTION 3)		
C400	DRY PANEL FILTER (SECTION 4)		
S100A	SOURCE C100 STACK		
S100B	SOURCE C100 STACK		
S200A	SOURCE C200 STACK		
S200B	SOURCE C200 STACK		
S300A	SOURCE C300 STACK		
S300B	SOURCE C300 STACK		
S400A	SOURCE C400 STACK		
S400B	SOURCE C400 STACK		

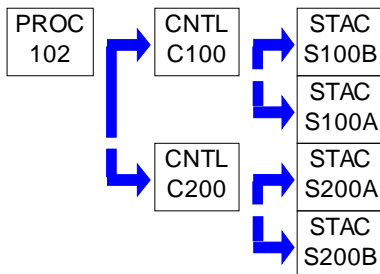
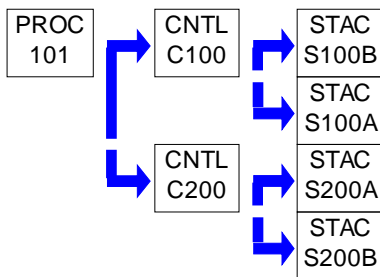
**PERMIT MAPS**

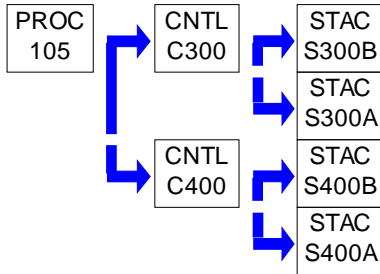
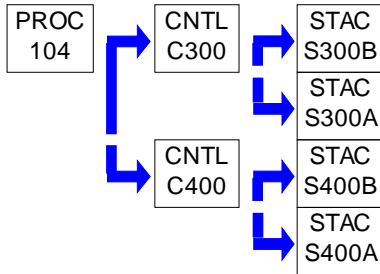
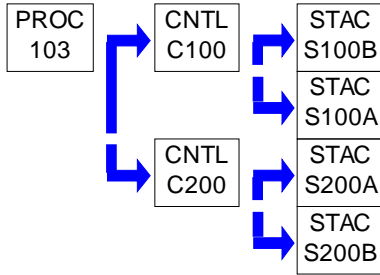
**PERMIT MAPS**

**SECTION B. General State Only Requirements****#001 [25 Pa. Code § 121.1]****Definitions.**

Words and terms that are not otherwise defined in this permit shall have the meanings set forth in Section 3 of the Air Pollution Control Act (35 P.S. § 4003) and in 25 Pa. Code § 121.1.

**#002 [25 Pa. Code § 127.446]****Operating Permit Duration.**

- (a) This operating permit is issued for a fixed term of five (5) years and shall expire on the date specified on Page 1 of this permit.
- (b) The terms and conditions of the expired permit shall automatically continue pending issuance of a new operating permit, provided the permittee has submitted a timely and complete application and paid applicable fees required under 25 Pa. Code Chapter 127, Subchapter I and the Department is unable, through no fault of the permittee, to issue or deny a new permit before the expiration of the previous permit.

**#003 [25 Pa. Code §§ 127.412, 127.413, 127.414, 127.446 & 127.703(b)&(c)]****Permit Renewal.**

- (a) The permittee shall submit a timely and complete application for renewal of the operating permit to the appropriate Regional Air Program Manager. The application for renewal of the operating permit shall be submitted at least six (6) months and not more than 18 months before the expiration date of this permit.
- (b) The application for permit renewal shall include the current permit number, a description of any permit revisions that occurred during the permit term, and any applicable requirements that were promulgated and not incorporated into the permit during the permit term. An application is complete if it contains sufficient information to begin processing the application, has the applicable sections completed and has been signed by a responsible official.
- (c) The permittee shall submit with the renewal application a fee for the processing of the application and an additional annual administrative fee as specified in 25 Pa. Code § 127.703(b) and (c). The fees shall be made payable to "The Commonwealth of Pennsylvania - Clean Air Fund" and shall be for the amount specified in the following schedule specified in 25 Pa. Code § 127.703(b) and (c).
- (1) Three hundred dollars for applications filed during the 2000-2004 calendar years.
  - (2) Three hundred seventy-five dollars for applications filed for the calendar years beginning in 2005.
- (d) The renewal application shall also include submission of proof that the local municipality and county, in which the facility is located, have been notified in accordance with 25 Pa. Code § 127.413.
- (e) The application for renewal of the operating permit shall also include submission of supplemental compliance review forms in accordance with the requirements of 25 Pa. Code § 127.412(b) and § 127.412(j).
- (f) The permittee, upon becoming aware that any relevant facts were omitted or incorrect information was submitted in the permit application, shall promptly submit such supplementary facts or corrected information as necessary to address any requirements that become applicable to the source after the permittee submits a complete application, but prior to the date the Department takes action on the permit application.

**#004 [25 Pa. Code § 127.703]****Operating Permit Fees under Subchapter I.**

- (a) The permittee shall pay fees according to the following schedule specified in 25 Pa. Code § 127.703(b):
- (1) Three hundred dollars for applications filed during the 2000-2004 calendar years.
  - (2) Three hundred seventy-five dollars for applications filed for the calendar years beginning in 2005.

This fee schedule shall apply to the processing of an application for an operating permit as well as the extension,

**SECTION B. General State Only Requirements**

modification, revision, renewal, and re-issuance of each operating permit or part thereof.

(b) The permittee shall pay an annual operating permit administrative fee according to the fee schedule established in 25 Pa. Code § 127.703(c).

(1) Two hundred fifty dollars for applications filed during the 1995-1999 calendar years.

(2) Three hundred dollars for applications filed during the 2000-2004 calendar years.

(3) Three hundred seventy-five dollars for applications filed during the years beginning in 2005.

(c) The applicable fees shall be made payable to "The Commonwealth of Pennsylvania - Clean Air Fund".

**#005 [25 Pa. Code §§ 127.450 (a)(4) and 127.464]****Transfer of Operating Permits.**

(a) This operating permit may not be transferred to another person, except in cases of transfer-of-ownership that are documented and approved by the Department.

(b) In accordance with 25 Pa. Code § 127.450(a)(4), a change in ownership of the source shall be treated as an administrative amendment if the Department determines that no other change in the permit is required and a written agreement has been submitted to the Department identifying the specific date of the transfer of permit responsibility, coverage and liability between the current and the new permittee and a compliance review form has been submitted to, and the permit transfer has been approved by, the Department.

(c) This operating permit is valid only for those specific sources and the specific source locations described in this permit.

**#006 [25 Pa. Code § 127.441 and 35 P.S. § 4008]****Inspection and Entry.**

(a) Upon presentation of credentials and other documents as may be required by law, the permittee shall allow the Department or authorized representatives of the Department to perform the following:

(1) Enter at reasonable times upon the permittee's premises where a source is located or emissions related activity is conducted, or where records are kept under the conditions of this permit;

(2) Have access to and copy, at reasonable times, any records that are kept under the conditions of this permit;

(3) Inspect at reasonable times, any facilities, equipment including monitoring and air pollution control equipment, practices, or operations regulated or required under this permit;

(4) Sample or monitor, at reasonable times, any substances or parameters, for the purpose of assuring compliance with the permit or applicable requirements as authorized by the Clean Air Act, the Air Pollution Control Act, or the regulations promulgated under the Acts.

(b) Pursuant to 35 P.S. § 4008, no person shall hinder, obstruct, prevent or interfere with the Department or its personnel in the performance of any duty authorized under the Air Pollution Control Act or regulations adopted thereunder including denying the Department access to a source at this facility. Refusal of entry or access may constitute grounds for permit revocation and assessment of criminal and/or civil penalties.

(c) Nothing in this permit condition shall limit the ability of the EPA to inspect or enter the premises of the permittee in accordance with Section 114 or other applicable provisions of the Clean Air Act.

**#007 [25 Pa. Code §§ 127.441 & 127.444]****Compliance Requirements.**

(a) The permittee shall comply with the conditions of this operating permit. Noncompliance with this permit constitutes

**SECTION B. General State Only Requirements**

a violation of the Clean Air Act and the Air Pollution Control Act and is grounds for one or more of the following:

- (1) Enforcement action
- (2) Permit termination, revocation and reissuance or modification
- (3) Denial of a permit renewal application

(b) A person may not cause or permit the operation of a source which is subject to 25 Pa. Code Article III unless the source(s) and air cleaning devices identified in the application for the plan approval and operating permit and the plan approval issued for the source is operated and maintained in accordance with specifications in the applications and the conditions in the plan approval and operating permit issued by the Department. A person may not cause or permit the operation of an air contamination source subject to 25 Pa. Code Chapter 127 in a manner inconsistent with good operating practices.

(c) For purposes of Sub-condition (b) of this permit condition, the specifications in applications for plan approvals and operating permits are the physical configurations and engineering design details which the Department determines are essential for the permittee's compliance with the applicable requirements in this State-Only permit. Nothing in this sub-condition shall be construed to create an independent affirmative duty upon the permittee to obtain a predetermination from the Department for physical configuration or engineering design detail changes made by the permittee.

**#008 [25 Pa. Code § 127.441]****Need to Halt or Reduce Activity Not a Defense.**

It shall not be a defense for the permittee in an enforcement action that it was necessary to halt or reduce the permitted activity in order to maintain compliance with the conditions of this permit.

**#009 [25 Pa. Code §§ 127.442(a) & 127.461]****Duty to Provide Information.**

(a) The permittee shall submit reports to the Department containing information the Department may prescribe relative to the operation and maintenance of each source at the facility.

(b) The permittee shall furnish to the Department, in writing, information that the Department may request to determine whether cause exists for modifying, revoking and reissuing, or terminating this permit, or to determine compliance with the permit. Upon request, the permittee shall also furnish to the Department copies of records that the permittee is required to maintain in accordance with this permit.

**#010 [25 Pa. Code § 127.461]****Revising an Operating Permit for Cause.**

This operating permit may be terminated, modified, suspended or revoked and reissued if one or more of the following applies:

- (1) The permittee constructs or operates the source subject to the operating permit so that it is in violation of the Air Pollution Control Act, the Clean Air Act, the regulations thereunder, a plan approval, a permit or in a manner that causes air pollution.
- (2) The permittee fails to properly or adequately maintain or repair an air pollution control device or equipment attached to or otherwise made a part of the source.
- (3) The permittee has failed to submit a report required by the operating permit or an applicable regulation.
- (4) The EPA determines that the permit is not in compliance with the Clean Air Act or the regulations thereunder.

**#011 [25 Pa. Code §§ 127.450 & 127.462]****Operating Permit Modifications**

(a) The permittee is authorized to make administrative amendments, minor operating permit modifications and



**SECTION B. General State Only Requirements**

significant operating permit modifications, under this permit, as outlined below:

(b) Administrative Amendments. The permittee shall make administrative operating permit amendments (as defined in 25 Pa. Code § 127.450(a)), according to procedures specified in § 127.450 unless precluded by the Clean Air Act or its regulations.

(c) Minor Operating Permit Modifications. The permittee shall make minor operating permit modifications (as defined 25 Pa. Code § 121.1) in accordance with 25 Pa. Code § 127.462.

(d) Permit modifications which do not qualify as minor permit modifications under 25 Pa. Code § 127.541 will be treated as a significant operating permit revision subject to the public notification procedures in §§ 127.424 and 127.425.

**#012 [25 Pa. Code § 127.441]****Severability Clause.**

The provisions of this permit are severable, and if any provision of this permit is determined by a court of competent jurisdiction to be invalid or unenforceable, such a determination will not affect the remaining provisions of this permit.

**#013 [25 Pa. Code § 127.449]****De Minimis Emission Increases.**

(a) This permit authorizes de minimis emission increases in accordance with 25 Pa. Code § 127.449 so long as the permittee provides the Department with seven (7) days prior written notice before commencing any de minimis emissions increase. The written notice shall:

(1) Identify and describe the pollutants that will be emitted as a result of the de minimis emissions increase.

(2) Provide emission rates expressed in tons per year and in terms necessary to establish compliance consistent with any applicable requirement.

(b) The Department may disapprove or condition de minimis emission increases at any time.

(c) Except as provided below in (d), the permittee is authorized to make de minimis emission increases (expressed in tons per year) up to the following amounts without the need for a plan approval or prior issuance of a permit modification:

(1) Four tons of carbon monoxide from a single source during the term of the permit and 20 tons of carbon monoxide at the facility during the term of the permit.

(2) One ton of NO<sub>x</sub> from a single source during the term of the permit and 5 tons of NO<sub>x</sub> at the facility during the term of the permit.

(3) One and six-tenths tons of the oxides of sulfur from a single source during the term of the permit and 8.0 tons of oxides of sulfur at the facility during the term of the permit.

(4) Six-tenths of a ton of PM<sub>10</sub> from a single source during the term of the permit and 3.0 tons of PM<sub>10</sub> at the facility during the term of the permit. This shall include emissions of a pollutant regulated under Section 112 of the Clean Air Act unless precluded by the Clean Air Act, the regulations thereunder or 25 Pa. Code Article III.

(5) One ton of VOCs from a single source during the term of the permit and 5.0 tons of VOCs at the facility during the term of the permit. This shall include emissions of a pollutant regulated under Section 112 of the Clean Air Act unless precluded by the Clean Air Act, the regulations thereunder or 25 Pa. Code Article III.

(6) Other sources and classes of sources determined to be of minor significance by the Department.

(d) In accordance with § 127.14, the permittee is authorized to install the following minor sources without the need for a plan approval or permit modification:

**SECTION B. General State Only Requirements**

(1) Air conditioning or ventilation systems not designed to remove pollutants generated or released from other sources.

(2) Combustion units rated at 2,500,000 or less Btu per hour of heat input.

(3) Combustion units with a rated capacity of less than 10,000,000 Btu per hour heat input fueled by natural gas supplied by a public utility or by commercial fuel oils which are No. 2 or lighter, viscosity less than or equal to 5.82 c St, and which meet the sulfur content requirements of 25 Pa. Code §123.22 (relating to combustion units). For purposes of this permit, commercial fuel oil shall be virgin oil which has no reprocessed, recycled or waste material added.

(4) Space heaters which heat by direct heat transfer.

(5) Laboratory equipment used exclusively for chemical or physical analysis.

(6) Other sources and classes of sources determined to be of minor significance by the Department.

(e) This permit does not authorize de minimis emission increases if the emissions increase would cause one or more of the following:

(1) Increase the emissions of a pollutant regulated under Section 112 of the Clean Air Act except as authorized in Subparagraphs (c)(4) and (5) of this permit condition.

(2) Subject the facility to the prevention of significant deterioration requirements in 25 Pa. Code Chapter 127, Subchapter D and/or the new source review requirements in Subchapter E.

(3) Violate any applicable requirement of this permit, the Air Pollution Control Act, the Clean Air Act, or the regulations promulgated under either of the acts.

(f) Emissions authorized under this permit condition shall be included in the monitoring, recordkeeping and reporting requirements of this permit.

(g) Except for de minimis emission increases, installation of minor sources made pursuant to this permit condition and Plan Approval Exemptions under 25 Pa. Code § 127.14 (relating to exemptions), the permittee is prohibited from making changes or engaging in activities that are not specifically authorized under this permit without first applying for a plan approval. In accordance with § 127.14(b), a plan approval is not required for the construction, modification, reactivation, or installation of the sources creating the de minimis emissions increase.

(h) The permittee may not meet de minimis emission threshold levels by offsetting emission increases or decreases at the same source.

**#014 [25 Pa. Code § 127.3]****Operational Flexibility.**

The permittee is authorized to make changes within the facility in accordance with the regulatory provisions outlined in 25 Pa. Code § 127.3 (relating to operational flexibility) to implement the operational flexibility requirements provisions authorized under Section 6.1(i) of the Air Pollution Control Act and the operational flexibility terms and conditions of this permit. The provisions in 25 Pa. Code Chapter 127 which implement the operational flexibility requirements include the following:

(1) Section 127.14 (relating to exemptions)

(2) Section 127.447 (relating to alternative operating scenarios)

(3) Section 127.448 (relating to emissions trading at facilities with Federally enforceable emissions caps)

(4) Section 127.449 (relating to de minimis emission increases)

(5) Section 127.450 (relating to administrative operating permit amendments)

**SECTION B. General State Only Requirements**

(6) Section 127.462 (relating to minor operating permit modifications)

(7) Subchapter H (relating to general plan approvals and general operating permits)

**#015 [25 Pa. Code § 127.11]****Reactivation**

(a) The permittee may not reactivate a source that has been out of operation or production for at least one year unless the reactivation is conducted in accordance with a plan approval granted by the Department or in accordance with reactivation and maintenance plans developed and approved by the Department in accordance with 25 Pa. Code § 127.11a(a).

(b) A source which has been out of operation or production for more than five (5) years but less than 10 years may be reactivated and will not be considered a new source if the permittee satisfies the conditions specified in 25 Pa. Code § 127.11a(b).

**#016 [25 Pa. Code § 127.36]****Health Risk-based Emission Standards and Operating Practice Requirements.**

(a) When needed to protect public health, welfare and the environment from emissions of hazardous air pollutants from new and existing sources, the permittee shall comply with the health risk-based emission standards or operating practice requirements imposed by the Department, except as precluded by §§ 6.6(d)(2) and (3) of the Air Pollution Control Act [35 P.S. § 4006.6(d)(2) and (3)].

(b) A person challenging a performance or emission standard established by the Department has the burden to demonstrate that performance or emission standard does not meet the requirements of Section 112 of the Clean Air Act.

**#017 [25 Pa. Code § 121.9]****Circumvention.**

No person may permit the use of a device, stack height which exceeds good engineering practice stack height, dispersion technique or other technique which, without resulting in reduction of the total amount of air contaminants emitted, conceals or dilutes an emission of air contaminants which would otherwise be in violation of 25 Pa. Code Article III, except that with prior approval of the Department, the device or technique may be used for control of malodors.

**#018 [25 Pa. Code §§ 127.402(d) & 127.442]****Reporting Requirements.**

(a) The permittee shall comply with the applicable reporting requirements of the Clean Air Act, the regulations thereunder, the Air Pollution Control Act and 25 Pa. Code Article III including Chapters 127, 135 and 139.

(b) The permittee shall submit reports to the Department containing information the Department may prescribe relative to the operation and maintenance of any air contamination source.

(c) Reports, test data, monitoring data, notifications and requests for renewal of the permit shall be submitted to the:

Regional Air Program Manager  
PA Department of Environmental Protection  
(At the address given in the permit transmittal letter, or otherwise notified)

(d) Any records or information including applications, forms, or reports submitted pursuant to this permit condition shall contain a certification by a responsible official as to truth, accuracy and completeness. The certifications submitted under this permit shall require a responsible official of the facility to certify that based on information and belief formed after reasonable inquiry, the statements and information in the documents are true, accurate and complete.

(e) Any records, reports or information submitted to the Department shall be available to the public except for such

**SECTION B. General State Only Requirements**

records, reports or information which meet the confidentiality requirements of § 4013.2 of the Air Pollution Control Act and §§ 112(d) and 114(c) of the Clean Air Act. The permittee may not request a claim of confidentiality for any emissions data generated for the facility.

**#019 [25 Pa. Code §§ 127.441(c) & 135.5]****Sampling, Testing and Monitoring Procedures.**

(a) The permittee shall comply with the monitoring, recordkeeping or reporting requirements of 25 Pa. Code Chapter 139 and the other applicable requirements of 25 Pa. Code Article III and additional requirements related to monitoring, reporting and recordkeeping required by the Clean Air Act and the regulations thereunder including the Compliance Assurance Monitoring requirements of 40 CFR Part 64, where applicable.

(b) Unless alternative methodology is required by the Clean Air Act and regulations adopted thereunder, sampling, testing and monitoring required by or used by the permittee to demonstrate compliance with any applicable regulation or permit condition shall be conducted in accordance with the requirements of 25 Pa. Code Chapter 139.

**#020 [25 Pa. Code §§ 127.441(c) and 135.5]****Recordkeeping.**

(a) The permittee shall maintain and make available, upon request by the Department, the following records of monitored information:

- (1) The date, place (as defined in the permit) and time of sampling or measurements.
- (2) The dates the analyses were performed.
- (3) The company or entity that performed the analyses.
- (4) The analytical techniques or methods used.
- (5) The results of the analyses.
- (6) The operating conditions as existing at the time of sampling or measurement.

(b) The permittee shall retain records of any required monitoring data and supporting information for at least five (5) years from the date of the monitoring, sample, measurement, report or application. Supporting information includes the calibration data and maintenance records and original strip-chart recordings for continuous monitoring instrumentation, and copies of reports required by the permit.

(c) The permittee shall maintain and make available to the Department upon request, records including computerized records that may be necessary to comply with the reporting, recordkeeping and emission statement requirements in 25 Pa. Code Chapter 135 (relating to reporting of sources). In accordance with 25 Pa. Code Chapter 135, § 135.5, such records may include records of production, fuel usage, maintenance of production or pollution control equipment or other information determined by the Department to be necessary for identification and quantification of potential and actual air contaminant emissions.

**#021 [25 Pa. Code § 127.441(a)]****Property Rights.**

This permit does not convey any property rights of any sort, or any exclusive privileges.

**#022 [25 Pa. Code § 127.447]****Alternative Operating Scenarios.**

The permittee is authorized to make changes at the facility to implement alternative operating scenarios identified in this permit in accordance with 25 Pa. Code § 127.447.

**SECTION C. Site Level Requirements****I. RESTRICTIONS.****Emission Restriction(s).****# 001 [25 Pa. Code §123.1]****Prohibition of certain fugitive emissions**

The permittee shall not allow the emission into the outdoor atmosphere of a fugitive air contaminant from a source other than the following:

- (a) Construction or demolition of buildings or structures.
- (b) Grading, paving, and maintenance of roads and streets.
- (c) Use of roads and streets. Emissions from material in or on trucks, railroad cars, and other vehicular equipment are not considered as emissions from use of roads and streets.
- (d) Clearing of land.
- (e) Stockpiling of materials.
- (f) Sources and classes of sources other than those identified in (a)-(e), above, for which the permittee has obtained a determination from the Department that fugitive emissions from the source, after appropriate control, meet the following requirements:
  - (1) The emissions are of minor significance with respect to causing air pollution; and
  - (2) The emissions are not preventing or interfering with the attainment or maintenance of any ambient air quality standard.

**# 002 [25 Pa. Code §123.2]****Fugitive particulate matter**

The permittee shall not allow the emission of fugitive particulate matter into the outdoor atmosphere from a source specified in Condition #001(a)-(f) of Section C if the emissions are visible at the point the emissions pass outside the permittee's property.

**# 003 [25 Pa. Code §123.31]****Limitations**

The permittee shall not allow the emission into the outdoor atmosphere of any malodorous air contaminants from any source in such a manner that the malodors are detectable outside the permittee's property.

**# 004 [25 Pa. Code §123.41]****Limitations**

The permittee shall not allow the emission into the outdoor atmosphere of visible air contaminants in such a manner that the opacity of the emission is either of the following:

- (a) Equal to or greater than 20% for a period or periods aggregating more than three minutes in any one hour.
- (b) Equal to or greater than 60% at any time.

**# 005 [25 Pa. Code §123.42]****Exceptions**

The emission limitations of Condition #004 of Section C shall not apply when:

- (a) The presence of uncombined water is the only reason for failure of the emission to meet the limitations.
- (b) The emission results from the operation of equipment used solely to train and test persons in observing the opacity of visible emissions.
- (c) The emission results from sources specified in Condition #001(a)-(f) of Section C.

**SECTION C. Site Level Requirements****# 006 [25 Pa. Code §129.14]****Open burning operations**

The permittee shall not allow the open burning of material on the permittee's property except when the open burning operations result from:

- (a) A fire set to prevent or abate a fire hazard, when approved by the Department and set by or under the supervision of a public officer.
- (b) A fire set for the purpose of instructing personnel in fire fighting, when approved by the Department.
- (c) A fire set for the prevention and control of disease or pests, when approved by the Department.
- (d) A fire set solely for recreational or ceremonial purposes.
- (e) A fire set solely for cooking food.

**II. TESTING REQUIREMENTS.****# 007 [25 Pa. Code §127.441]****Operating permit terms and conditions.**

The Department reserves the right to require exhaust stack testing of the sources referenced in this operating permit to measure emissions for purposes including verification of operating permit condition compliance and estimation of annual air emissions.

**# 008 [25 Pa. Code §139.1]****Sampling facilities.**

Upon the request of the Department, the permittee shall provide adequate sampling ports, safe sampling platforms and adequate utilities for the performance by the Department of tests on such source. In the request, the Department will set forth the time period in which the facilities shall be provided as well as the specifications for such facilities.

**# 009 [25 Pa. Code §139.11]****General requirements.**

- (a) As specified in 25 Pa. Code Section 139.11(1), performance tests shall be conducted while the source is operating at maximum routine operating conditions or under such other conditions, within the capacity of the equipment, as may be requested by the Department.
- (b) As specified in 25 Pa. Code Section 139.11(2), the Department will consider test results for approval where sufficient information is provided to verify the source conditions existing at the time of the test and where adequate data is available to show the manner in which the test was conducted. Information submitted to the Department shall include, at a minimum, all of the following:
  - (1) A thorough source description, including a description of any air cleaning devices and the flue.
  - (2) Process conditions, for example, the production rate, paint usage rate, and other conditions which may affect emissions from the process.
  - (3) The location of the sampling ports.
  - (4) Effluent characteristics, including velocity, temperature, moisture content, gas density (percentage CO, CO<sub>2</sub>, O<sub>2</sub>, and N<sub>2</sub>), static and barometric pressures.
  - (5) Sample collection techniques employed, including procedures used, equipment descriptions, and data to verify that isokinetic sampling for particulate matter collection occurred and that acceptable test conditions were met.
  - (6) Laboratory procedures and results.
  - (7) Calculated results.

**SECTION C. Site Level Requirements****III. MONITORING REQUIREMENTS.****# 010 [25 Pa. Code §123.43]****Measuring techniques**

Visible emissions may be measured using either of the following:

- (a) A device approved by the Department and maintained to provide accurate opacity measurements (e.g. Continuous Opacity Monitor).
- (b) Observers trained and certified in EPA Reference Method 9 to measure plume opacity with the naked eye; or with the aid of any device(s) approved by the Department.

**# 011 [25 Pa. Code §127.441]****Operating permit terms and conditions.**

The permittee shall conduct a monthly inspection around the plant periphery during daylight hours when the plant is in production to detect visible emissions, fugitive particulate matter emissions, and malodorous air contaminants. Monthly inspections are necessary to determine:

- (a) The presence of visible emissions. Visible emissions may be measured according to the methods specified in Section C, Condition #010. Alternately, plant personnel who observe visible emissions may report the incidence of visible emissions to the Department within two (2) hours of the incident and make arrangements for a certified observer to measure the visible emissions.
- (b) The presence of fugitive particulate matter emissions beyond the plant property boundaries, as stated in Section C, Condition #002.
- (c) The presence of malodorous air contaminants beyond the plant property boundaries, as stated in Section C, Condition #003.

**IV. RECORDKEEPING REQUIREMENTS.****# 012 [25 Pa. Code §127.441]****Operating permit terms and conditions.**

(a) The permittee shall maintain records of the monthly inspections referenced in Condition #011 of Section C. The records shall include, at a minimum, the following information:

- (1) The name of the company representative monitoring each inspection.
  - (2) The date and time of each inspection.
  - (3) The wind direction during each inspection.
  - (4) A description of the visible emissions, fugitive particulate matter emissions (beyond the plant property boundaries), and malodorous air contaminants (beyond the plant property boundaries) observed, if any, and actions taken to mitigate them. If no visible emissions or fugitive particulate matter emissions or malodors are observed, then document that none were observed.
- (b) The permittee shall retain these records for a minimum of five (5) years. The records shall be made available to the Department upon its request.

**V. REPORTING REQUIREMENTS.****# 013 [25 Pa. Code §127.442]****Reporting requirements.**

The permittee shall report malfunctions to the Department. A malfunction is any sudden, infrequent and not reasonably preventable failure of air pollution control equipment, process equipment, or a process to operate in a normal or usual manner that may result in an increase in air emissions. Failures that are caused in part by poor maintenance or careless operation are not malfunctions. Malfunctions shall be reported as follows:

**SECTION C. Site Level Requirements**

(a) Any malfunction which poses an imminent danger to the public health, safety, welfare, and environment, shall be immediately reported to the Department by telephone. Telephone reports can be made to the Air Quality Program at 717-705-4886 during normal business hours or to the Department's Emergency Hotline at 1-866-825-0208. The telephone report of such malfunctions shall occur no later than two (2) hours after the incident. The permittee shall submit a written report of instances of such malfunctions to the Department within three (3) days of the telephone report.

(b) Unless otherwise required by this operating permit, any other malfunction that is not subject to the reporting requirements of part (a), above, shall be reported to the Department, in writing, within five (5) days of malfunction discovery.

**# 014 [25 Pa. Code §135.3]****Reporting**

(a) An annual air emissions report for a given calendar year is due no later than March 1 of the following year and shall be submitted to the Air Quality District Supervisor at the following address, unless otherwise specified:

PA DEP  
Air Quality Program  
909 Elmerton Avenue  
Harrisburg, PA 17110

(b) The permittee may request an extension of time from the Department for the filing of the air emissions report specified in part (a), above, and the Department may grant the extension for reasonable cause.

**VI. WORK PRACTICE REQUIREMENTS.****# 015 [25 Pa. Code §123.1]****Prohibition of certain fugitive emissions**

The permittee shall take all reasonable actions to prevent particulate matter from becoming airborne from any source specified in Condition #001(a)-(f) of Section C. These actions shall include, but not be limited to, the following:

- (a) Use, where possible, of water or chemicals for control of dust in the demolition of buildings or structures, construction operations, the grading of roads, or the clearing of land.
- (b) Application of asphalt, oil, water, or suitable chemicals on dirt roads, material stockpiles and other surfaces which may give rise to airborne dusts.
- (c) Paving and maintenance of roadways.
- (d) Prompt removal of earth or other material from paved streets onto which earth or other material has been transported by trucking or earth moving equipment, erosion by water, or other means.

**# 016 [25 Pa. Code §127.444]****Compliance requirements.**

The permittee shall operate and maintain all sources and any air cleaning devices identified in this operating permit in accordance with the manufacturer's recommendations/specifications, as well as in a manner consistent with good operating practices.

**VII. ADDITIONAL REQUIREMENTS.**

No additional requirements exist except as provided in other sections of this permit including Section B (State Only General Requirements).

**VIII. COMPLIANCE CERTIFICATION.**

No additional compliance certifications exist except as provided in other sections of this permit including Section B (relating to State Only General Requirements).

**IX. COMPLIANCE SCHEDULE.**





**SECTION C. Site Level Requirements**

No compliance milestones exist.

**SECTION D. Source Level Requirements**

Source ID: 101

Source Name: PORTABLE SPRAY PAINT UNIT 1

Source Capacity/Throughput: 10.000 Lbs/HR VOC

Conditions for this source occur in the following groups: G001  
G002**I. RESTRICTIONS.**

No additional requirements exist except as provided in other sections of this permit including Section B (State Only General Requirements) and/or Section E (Source Group Restrictions).

**II. TESTING REQUIREMENTS.**

No additional testing requirements exist except as provided in other sections of this permit including Section B (State Only General Requirements) and/or Section E (Source Group Restrictions).

**III. MONITORING REQUIREMENTS.**

No additional monitoring requirements exist except as provided in other sections of this permit including Section B (State Only General Requirements) and/or Section E (Source Group Restrictions).

**IV. RECORDKEEPING REQUIREMENTS.**

No additional record keeping requirements exist except as provided in other sections of this permit including Section B (State Only General Requirements) and/or Section E (Source Group Restrictions).

**V. REPORTING REQUIREMENTS.**

No additional reporting requirements exist except as provided in other sections of this permit including Section B (State Only General Requirements) and/or Section E (Source Group Restrictions).

**VI. WORK PRACTICE REQUIREMENTS.**

No additional work practice requirements exist except as provided in other sections of this permit including Section B (State Only General Requirements) and/or Section E (Source Group Restrictions).

**VII. ADDITIONAL REQUIREMENTS.**

No additional requirements exist except as provided in other sections of this permit including Section B (State Only General Requirements) and/or Section E (Source Group Restrictions).

**SECTION D. Source Level Requirements**

Source ID: 102

Source Name: PORTABLE SPRAY PAINT UNIT 2

Source Capacity/Throughput: 10.000 Lbs/HR VOC

Conditions for this source occur in the following groups: G001  
G002**I. RESTRICTIONS.**

No additional requirements exist except as provided in other sections of this permit including Section B (State Only General Requirements) and/or Section E (Source Group Restrictions).

**II. TESTING REQUIREMENTS.**

No additional testing requirements exist except as provided in other sections of this permit including Section B (State Only General Requirements) and/or Section E (Source Group Restrictions).

**III. MONITORING REQUIREMENTS.**

No additional monitoring requirements exist except as provided in other sections of this permit including Section B (State Only General Requirements) and/or Section E (Source Group Restrictions).

**IV. RECORDKEEPING REQUIREMENTS.**

No additional record keeping requirements exist except as provided in other sections of this permit including Section B (State Only General Requirements) and/or Section E (Source Group Restrictions).

**V. REPORTING REQUIREMENTS.**

No additional reporting requirements exist except as provided in other sections of this permit including Section B (State Only General Requirements) and/or Section E (Source Group Restrictions).

**VI. WORK PRACTICE REQUIREMENTS.**

No additional work practice requirements exist except as provided in other sections of this permit including Section B (State Only General Requirements) and/or Section E (Source Group Restrictions).

**VII. ADDITIONAL REQUIREMENTS.**

No additional requirements exist except as provided in other sections of this permit including Section B (State Only General Requirements) and/or Section E (Source Group Restrictions).

**SECTION D. Source Level Requirements**

Source ID: 103

Source Name: PORTABLE SPRAY PAINT UNIT 3

Source Capacity/Throughput: 10.000 Lbs/HR VOC

Conditions for this source occur in the following groups: G001  
G002

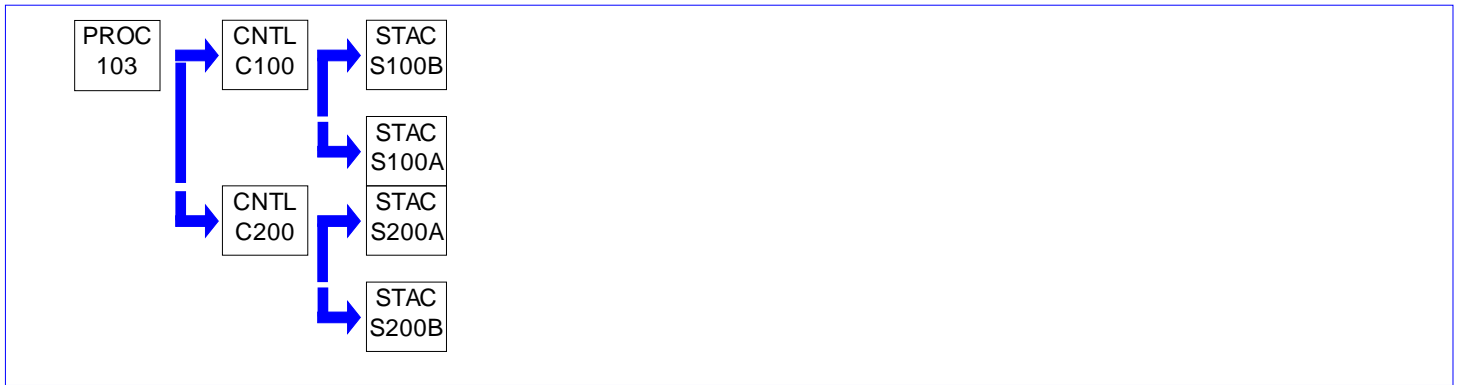
**I. RESTRICTIONS.**

No additional requirements exist except as provided in other sections of this permit including Section B (State Only General Requirements) and/or Section E (Source Group Restrictions).

**II. TESTING REQUIREMENTS.**

No additional testing requirements exist except as provided in other sections of this permit including Section B (State Only General Requirements) and/or Section E (Source Group Restrictions).

**III. MONITORING REQUIREMENTS.**

No additional monitoring requirements exist except as provided in other sections of this permit including Section B (State Only General Requirements) and/or Section E (Source Group Restrictions).

**IV. RECORDKEEPING REQUIREMENTS.**

No additional record keeping requirements exist except as provided in other sections of this permit including Section B (State Only General Requirements) and/or Section E (Source Group Restrictions).

**V. REPORTING REQUIREMENTS.**

No additional reporting requirements exist except as provided in other sections of this permit including Section B (State Only General Requirements) and/or Section E (Source Group Restrictions).

**VI. WORK PRACTICE REQUIREMENTS.**

No additional work practice requirements exist except as provided in other sections of this permit including Section B (State Only General Requirements) and/or Section E (Source Group Restrictions).

**VII. ADDITIONAL REQUIREMENTS.**

No additional requirements exist except as provided in other sections of this permit including Section B (State Only General Requirements) and/or Section E (Source Group Restrictions).

**SECTION D. Source Level Requirements**

Source ID: 104

Source Name: PORTABLE SPRAY PAINT UNIT 4

Source Capacity/Throughput: 10.000 Lbs/HR VOC

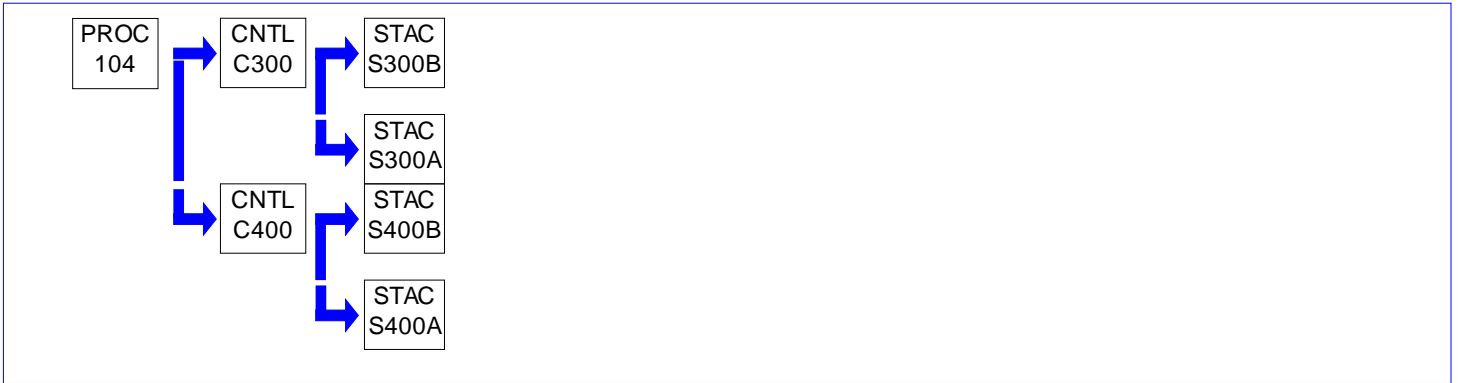
Conditions for this source occur in the following groups: G001  
G002**I. RESTRICTIONS.**

No additional requirements exist except as provided in other sections of this permit including Section B (State Only General Requirements) and/or Section E (Source Group Restrictions).

**II. TESTING REQUIREMENTS.**

No additional testing requirements exist except as provided in other sections of this permit including Section B (State Only General Requirements) and/or Section E (Source Group Restrictions).

**III. MONITORING REQUIREMENTS.**

No additional monitoring requirements exist except as provided in other sections of this permit including Section B (State Only General Requirements) and/or Section E (Source Group Restrictions).

**IV. RECORDKEEPING REQUIREMENTS.**

No additional record keeping requirements exist except as provided in other sections of this permit including Section B (State Only General Requirements) and/or Section E (Source Group Restrictions).

**V. REPORTING REQUIREMENTS.**

No additional reporting requirements exist except as provided in other sections of this permit including Section B (State Only General Requirements) and/or Section E (Source Group Restrictions).

**VI. WORK PRACTICE REQUIREMENTS.**

No additional work practice requirements exist except as provided in other sections of this permit including Section B (State Only General Requirements) and/or Section E (Source Group Restrictions).

**VII. ADDITIONAL REQUIREMENTS.**

No additional requirements exist except as provided in other sections of this permit including Section B (State Only General Requirements) and/or Section E (Source Group Restrictions).

**SECTION D. Source Level Requirements**

Source ID: 105

Source Name: PORTABLE SPRAY PAINT UNIT 5

Source Capacity/Throughput: 10.000 Lbs/HR VOC

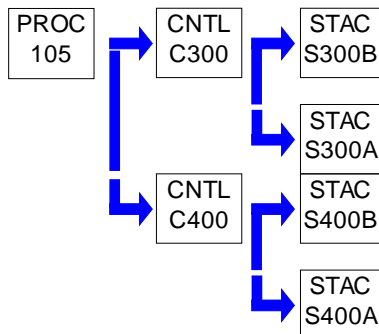
Conditions for this source occur in the following groups: G001  
G002**I. RESTRICTIONS.**

No additional requirements exist except as provided in other sections of this permit including Section B (State Only General Requirements) and/or Section E (Source Group Restrictions).

**II. TESTING REQUIREMENTS.**

No additional testing requirements exist except as provided in other sections of this permit including Section B (State Only General Requirements) and/or Section E (Source Group Restrictions).

**III. MONITORING REQUIREMENTS.**

No additional monitoring requirements exist except as provided in other sections of this permit including Section B (State Only General Requirements) and/or Section E (Source Group Restrictions).

**IV. RECORDKEEPING REQUIREMENTS.**

No additional record keeping requirements exist except as provided in other sections of this permit including Section B (State Only General Requirements) and/or Section E (Source Group Restrictions).

**V. REPORTING REQUIREMENTS.**

No additional reporting requirements exist except as provided in other sections of this permit including Section B (State Only General Requirements) and/or Section E (Source Group Restrictions).

**VI. WORK PRACTICE REQUIREMENTS.**

No additional work practice requirements exist except as provided in other sections of this permit including Section B (State Only General Requirements) and/or Section E (Source Group Restrictions).

**VII. ADDITIONAL REQUIREMENTS.**

No additional requirements exist except as provided in other sections of this permit including Section B (State Only General Requirements) and/or Section E (Source Group Restrictions).

**SECTION E. Source Group Restrictions.**

Group Name: G001

Group Description: SURFACE COATING OPERATIONS

Sources included in this group

ID	Name
101	PORTABLE SPRAY PAINT UNIT 1
102	PORTABLE SPRAY PAINT UNIT 2
103	PORTABLE SPRAY PAINT UNIT 3
104	PORTABLE SPRAY PAINT UNIT 4
105	PORTABLE SPRAY PAINT UNIT 5

**I. RESTRICTIONS.****Emission Restriction(s).****# 001 [25 Pa. Code §127.1]****Purpose.**

[Additional authority for this permit condition is also derived from Plan Approval Nos. 67-05099 and 67-05099B]

The permittee shall not allow the emission into the outdoor atmosphere of particulate matter (PM) from the Group G001 sources in a manner that the concentration of PM in the effluent gas exceeds 0.02 grain per dry standard cubic foot.

**II. TESTING REQUIREMENTS.****# 002 [25 Pa. Code §127.441]****Operating permit terms and conditions.**

[Additional authority for this permit condition is also derived from Plan Approval Nos. 67-05099 and 67-05099B]

The permittee shall demonstrate the VOC/HAP content of each surface coating by one of the following methods:

(a) For surface coatings applied as they are received from the manufacturer, the permittee may demonstrate compliance with the applicable standard by obtaining EPA Method 24 certification testing from the manufacturer, or by maintaining VOC/HAP data sheets from the manufacturer.

(b) In the absence of EPA Method 24 certification testing from the manufacturer, or VOC/HAP data sheets from the manufacturer, allowed under part (a), above, the permittee shall perform EPA Method 24 certification testing on all surface coatings applied as received from the manufacturer.

(c) The permittee may use calculated VOC content values in lieu of EPA Method 24 certification testing for multi-part surface coatings where the permittee maintains VOC/HAP data sheets for all surface coating constituents (i.e. coatings, pigments, thinners/cutting solvents), and also maintains documentation from the manufacturer as to the recommended mix ratio of the parts. In the event of any inconsistency between the calculated VOC content and data obtained from EPA Method 24 certification testing, the latter shall take precedence.

**III. MONITORING REQUIREMENTS.**

No additional monitoring requirements exist except as provided in other sections of this permit including Section B (State Only General Requirements).

**IV. RECORDKEEPING REQUIREMENTS.****# 003 [25 Pa. Code §127.441]****Operating permit terms and conditions.**

[Additional authority for this permit condition is also derived from Plan Approval Nos. 67-05099 and 67-05099B]

The permittee shall maintain records of all EPA Method 24 certification testing performed (or MSDSs, CPDSs, PDSs or EDSSs), as well as any solids content testing performed, for the most recent five (5) year period. The records shall be made available to the Department upon its request.

**SECTION E. Source Group Restrictions.****V. REPORTING REQUIREMENTS.****# 004 [25 Pa. Code §135.3]****Reporting**

[Additional authority for this permit condition is also derived from Plan Approval Nos. 67-05099 and 67-05099B]

(a) The permittee shall include the following information for each coating, thinner and other component(s) applied at the Group G001 sources in the annual air emissions report referenced in Condition #014 of Section C:

- (1) Name and identification number
- (2) The VOC content of the coating, thinner and other component(s) as supplied (pounds VOC per gallon of coating solids, minus water and exempt VOCs)
- (3) The VOC content of the as applied surface coating (pounds VOC per gallon of coating solids, minus water and exempt VOCs)
- (4) Coating density (pounds per gallon, at 25°C)
- (5) Percent total volatiles (by weight)
- (6) Percent water (by weight)
- (7) Percent solids (by volume and weight)
- (8) Percent exempt VOC(s) (by weight)
- (9) Percent VOCs (by weight)
- (10) Mix ratio for the as applied surface coating
- (11) Percent hazardous air pollutant(s) [HAP(s)] (by weight and by type)
- (12) Gallons per month used
- (13) Pounds per month of VOC emissions
- (14) Pounds per month of HAP(s) emissions (by type)
- (15) Tons total per each month's consecutive 12-month period of VOC emissions
- (16) Tons total per each month's consecutive 12-month period of HAP(s) emissions (by type)

The permittee shall also include the type and amount (gallons per month) of VOC/HAP-containing cleanup solvent(s) collectively used in conjunction with the operation of the Group G001 sources (i.e. cleaning activities and wash-off operations), as well as the resultant monthly VOC and HAP(s) emissions.

This information shall be reported using VOC Worksheets supplied by the Department, or an equivalent format acceptable to the Department.

(b) The total days and approximate hours of operation for the Group G001 sources shall also be included in the annual report.

(c) The permittee shall provide the following information for waste coatings, solvents, or mixtures sent off-site for recycling or disposal in order to obtain credit for VOC and HAP(s) emissions reporting for (a)(13) and (a)(14), respectively, above:

- (1) Pounds or gallons per month of waste coatings, solvents, or mixtures shipped from the facility
- (2) Waste profile or sampling data for a representative shipment (conducted a minimum of once each calendar year)
- (3) Identification of the waste disposal company for each shipment

**VI. WORK PRACTICE REQUIREMENTS.****# 005 [25 Pa. Code §127.441]****Operating permit terms and conditions.**

[Additional authority for this permit condition is also derived from Plan Approval Nos. 67-05099 and 67-05099B]

The permittee shall not allow the operation of any of the Group G001 sources unless the exhaust air is directed through dry panel filters for particulate matter (PM) control.

**# 006 [25 Pa. Code §127.441]****Operating permit terms and conditions.**

[Additional authority for this permit condition is also derived from Plan Approval Nos. 67-05099 and 67-05099B]

The permittee shall keep all surface coating containers which contain VOCs tightly closed when not in use. Spills of materials containing VOCs shall be cleaned up immediately with cleaning cloths or other methods that will minimize the



**SECTION E. Source Group Restrictions.**

evaporation of VOCs into the atmosphere. Solvent-laden cleaning cloths shall be kept in closed containers when not in use.

**VII. ADDITIONAL REQUIREMENTS.**

No additional requirements exist except as provided in other sections of this permit including Section B (State Only General Requirements).

**SECTION E. Source Group Restrictions.**

Group Name: G002

Group Description: 25 Pa Code 129.52d requirements

**Sources included in this group**

ID	Name
101	PORTABLE SPRAY PAINT UNIT 1
102	PORTABLE SPRAY PAINT UNIT 2
103	PORTABLE SPRAY PAINT UNIT 3
104	PORTABLE SPRAY PAINT UNIT 4
105	PORTABLE SPRAY PAINT UNIT 5

**I. RESTRICTIONS.**

No additional requirements exist except as provided in other sections of this permit including Section B (State Only General Requirements).

**II. TESTING REQUIREMENTS.**

No additional testing requirements exist except as provided in other sections of this permit including Section B (State Only General Requirements).

**III. MONITORING REQUIREMENTS.**

No additional monitoring requirements exist except as provided in other sections of this permit including Section B (State Only General Requirements).

**IV. RECORDKEEPING REQUIREMENTS.**

No additional record keeping requirements exist except as provided in other sections of this permit including Section B (State Only General Requirements).

**V. REPORTING REQUIREMENTS.**

No additional reporting requirements exist except as provided in other sections of this permit including Section B (State Only General Requirements).

**VI. WORK PRACTICE REQUIREMENTS.**

No additional work practice requirements exist except as provided in other sections of this permit including Section B (State Only General Requirements).

**VII. ADDITIONAL REQUIREMENTS.****# 001 [25 Pa. Code §127.441]****Operating permit terms and conditions.**

§ 129.52d. Control of VOC emissions from miscellaneous metal parts surface coating processes, miscellaneous plastic parts surface coating processes and pleasure craft surface coatings.

(a) Applicability.

(1) This section applies to the owner and operator of a miscellaneous metal part surface coating process or miscellaneous plastic part surface coating process, or both, if the total actual VOC emissions from all miscellaneous metal part coating units and miscellaneous plastic part coating units, including related cleaning activities, at the facility are equal to or greater than 2.7 tons per 12-month rolling period, before consideration of controls.

(2) This section applies, as specified, to the owner and operator of a miscellaneous metal part surface coating process or miscellaneous plastic part surface coating process, or both, if the total actual VOC emissions from all miscellaneous metal part coating units and miscellaneous plastic part coating units, including related cleaning activities, at the facility are below 2.7 tons per 12-month rolling period, before consideration of controls.

(3) Compliance with the VOC emission limits and other requirements of this section assures compliance with the VOC

**SECTION E. Source Group Restrictions.**

emission limits and other requirements of § 129.52 (relating to surface coating processes) for the miscellaneous metal parts and products surface coating processes as specified in § 129.52, Table I, Category 10.

(4) If an owner or operator elects to comply with § 129.52e (relating to control of VOC emissions from automobile and light-duty truck assembly surface coating operations and heavier vehicle coating operations) under § 129.52e(a)(2) or (3), then § 129.52e instead of this section applies to the separate coating line at the facility, or to the coating of a body or body part for a new heavier vehicle at the facility, or both, for which the election is made.

(5) This section does not apply to an owner or operator in the use or application of the following:

(i) Aerosol coatings that meet the requirements of 40 CFR Part 59, Subpart E (relating to National volatile organic compound emission standards for aerosol coatings).

(ii) Aerospace coatings.

(iii) Architectural coatings.

(iv) Automobile refinishing coatings.

(v) Auto and light-duty truck assembly coatings.

(vi) Can, coil or magnet wire coatings.

(vii) Coating applied to a test panel or coupon, or both, in research and development, quality control or performance testing activities, if records are maintained as required under subsections (e) and (f).

(viii) Fiberglass boat manufacturing materials.

(ix) Flat wood paneling coatings.

(x) Large appliance coatings.

(xi) Metal furniture coatings.

(xii) Miscellaneous industrial adhesives.

(xiii) Paper, film and foil coatings.

(xiv) Shipbuilding and repair coatings.

(xv) Wood furniture coatings.

(b) Definitions. [INCORPORATED BY REFERENCE]

(c) [NA - NO EXISTING RACT PERMIT]

(d) Emission limitations. Beginning January 1, 2017, a person subject to subsection (a)(1) may not cause or permit the emission into the outdoor atmosphere of VOCs from a miscellaneous metal part coating unit or miscellaneous plastic part coating unit, or both, unless emissions of VOCs are controlled in accordance with paragraph (1), (2) or (3).

(1) Compliant materials option. The VOC content of each miscellaneous metal part coating or each miscellaneous plastic part coating, as applied, excluding water and exempt compounds, is equal to or less than the VOC content limit for the applicable coating category specified in the applicable table of VOC content limits in Tables I—V.

Table I. VOC Content Limits for Metal Parts and Products Surface Coatings  
Weight of VOC per Volume of Coating,  
Less Water and Exempt Compounds, as Applied

**SECTION E. Source Group Restrictions.**

Coating Category	Air Dried		Baked	
	kg VOC/ l coating	lb VOC/ gal coating	kg VOC/ l coating	lb VOC/ gal coating
Prefabricated Architectural One-component	0.42	3.5	0.28	2.3
Prefabricated Architectural Multicomponent	0.42	3.5	0.28	2.3

(2)-(3) [NA – NO VOC CONTROL DEVICE]

(4) Least restrictive VOC limit. If more than one VOC content limit or VOC emission rate limit applies to a specific coating, then the least restrictive VOC content limit or VOC emission rate limit applies.

(5) Coatings not listed in Table I, II, VI or VII. For a miscellaneous metal part or miscellaneous plastic part coating that does not meet the coating categories listed in Table I, II, VI or VII, the VOC content limit or VOC emission rate limit shall be determined by classifying the coating as a general one component coating or general multicomponent coating. The corresponding general one component coating or general multicomponent coating limit applies.

(6) Coatings not listed in Table IV or IX. [NA – FACILITY DOES NOT USE PLEASURE CRAFT COATINGS]

(e) Compliance and monitoring requirements.

(1) All owners and operators. Regardless of the facility's VOC emissions, the owner or operator of a miscellaneous metal part surface coating process or miscellaneous plastic part surface coating process, or both, subject to subsection (a)(1) or (2), shall comply with this section as specified throughout this section. For an owner or operator subject only to subsection (a)(2), the compliance requirements are the recordkeeping requirements in subsection (f)(2).

(2) [NA – NO VOC CONTROL DEVICE]

(f) Recordkeeping and reporting requirements.

(1) The owner or operator of a miscellaneous metal part coating unit or miscellaneous plastic part coating unit, or both, subject to subsection (a)(1) shall maintain monthly records sufficient to demonstrate compliance with this section. The records must include the following information:

(i) The following parameters for each coating, thinner, component and cleaning solvent as supplied:

(A) Name and identification number of the coating, thinner, other component or cleaning solvent.

(B) Volume used.

(C) Mix ratio.

(D) Density or specific gravity.

(E) Weight percent of total volatiles, water, solids and exempt solvents.

(F) Volume percent of total volatiles, water and exempt solvents for the applicable table of limits in Tables I—V.

(G) Volume percent of solids for the applicable table of limits in Tables VI—IX.

(ii) The VOC content of each coating, thinner, other component and cleaning solvent as supplied.

(iii) The VOC content of each as applied coating or cleaning solvent.

(iv) The calculations performed for each applicable requirement under subsections (d) and (e).

**SECTION E. Source Group Restrictions.**

- (v) The information required in a plan approval issued under subsection (e)(2).
- (2) An owner or operator subject to subsection (a)(2), or otherwise claiming an exemption or exception in this section, shall maintain records sufficient to verify the applicability of subsection (a)(2), the exemption or exception. Records maintained for compliance demonstrations may include purchase, use, production and other records.
- (3) The records shall be maintained onsite for 2 years, unless a longer period is required by an order, plan approval or operating permit issued under Chapter 127 (relating to construction, modification, reactivation and operation of sources).
- (4) The records shall be submitted to the Department in an acceptable format upon receipt of a written request from the Department.
- (g) Coating application methods. A person subject to subsection (a)(1) may not cause or permit the emission into the outdoor atmosphere of VOCs from a miscellaneous metal part coating unit or miscellaneous plastic part coating unit, or both, unless the coatings are applied using one or more of the following coating application methods:
- (1) Electrostatic coating.
  - (2) Flow coating.
  - (3) Dip coating, including electrodeposition.
  - (4) Roll coating.
  - (5) High volume-low pressure (HVLP) spray coating.
  - (6) Airless spray coating.
  - (7) Air-assisted airless spray coating.
  - (8) Other coating application method if approved in writing by the Department prior to use.
- (i) The coating application method must be capable of achieving a transfer efficiency equivalent to or better than that achieved by HVLP spray coating.
- (ii) The owner or operator shall submit the request for approval to the Department in writing.
- (h) Exempt coatings and exempt coating unit operations.
- (1) The requirements of subsections (d) and (g) do not apply to the application of the following coatings to a metal part:
- (i) Stencil coating.
  - (ii) Safety-indicating coating.
  - (iii) Solid-film lubricant.
  - (iv) Electric-insulating and thermal-conducting coating.
  - (v) Magnetic data storage disk coating.
  - (vi) Plastic extruded onto metal parts to form a coating.
  - (vii) Powder coating.
- (2) [NA - NO PLASTIC PARTS COATINGS]

**SECTION E. Source Group Restrictions.**

(3) [NA - NO AUTOMOTIVE-TRANSPORTATION AND BUSINESS MACHINE PARTS COATINGS]

(4) The requirements of subsection (g) do not apply to the following activities:

(i) Application of a touch-up coating, repair coating or textured finish to a metal part.

(ii) Application of a powder coating to the following:

(A) Plastic part.

(B) Automotive-transportation plastic part.

(C) Business machine plastic part.

(iii) Airbrush application of coating to a metal part or plastic part using no more than 5 gallons of coating per year.

(iv) Use of an add-on air pollution control device to comply with subsection (d).

(v) Application of extreme high-gloss coating in a pleasure craft surface coating operation.

(i) Work practice requirements for coating-related activities. The owner or operator of a miscellaneous metal part coating unit or miscellaneous plastic part coating unit, or both, subject to subsection (a)(1) shall comply with the following work practices for coating-related activities:

(1) Store all VOC-containing coatings, thinners or coating-related waste materials in closed containers.

(2) Ensure that mixing and storage containers used for VOC-containing coatings, thinners or coating-related waste materials are kept closed at all times, except when depositing or removing these coatings, thinners or waste materials.

(3) Minimize spills of VOC-containing coatings, thinners or coating-related waste materials and clean up spills immediately.

(4) Convey VOC-containing coatings, thinners or coating-related waste materials from one location to another in closed containers or pipes.

(j) Work practice requirements for cleaning materials. The owner or operator of a miscellaneous metal part coating unit or miscellaneous plastic part coating unit subject to subsection (a)(1) shall comply with the following work practices for cleaning materials:

(1) Store all VOC-containing cleaning materials and used shop towels in closed containers.

(2) Ensure that mixing vessels and storage containers used for VOC-containing cleaning materials are kept closed at all times except when depositing or removing these materials.

(3) Minimize spills of VOC-containing cleaning materials and clean up spills immediately.

(4) Convey VOC-containing cleaning materials from one location to another in closed containers or pipes.

(5) Minimize VOC emissions from cleaning of application, storage, mixing or conveying equipment by ensuring that equipment cleaning is performed without atomizing the cleaning solvent and all spent solvent is captured in closed containers.

(k) Measurements and calculations. To determine the properties of a coating or component used in a miscellaneous metal parts surface coating process or miscellaneous plastic parts surface coating process, measurements and calculations shall be performed according to one or more of the following:

(1) EPA Reference Method 24, Determination of Volatile Matter Content, Water Content, Density, Volume Solids, and Weight Solids of Surface Coatings, found at 40 CFR Part 60, Subpart D, Appendix A, including updates and revisions.

**SECTION E. Source Group Restrictions.**

- (2) Manufacturer's formulation data.
- (3) Sampling and testing done in accordance with the procedures and test methods specified in Chapter 139.
- (4) Other test method demonstrated to provide results that are acceptable for purposes of determining compliance with this section if prior approval is obtained in writing from the Department.
- (5) [NA – NO VOC CONTROL DEVICE]
- (6) EPA calculations information in the following:
  - (i) A Guideline for Surface Coating Calculations, EPA-340/1-86-016, including updates and revisions.
  - (ii) Procedures for Certifying Quantity of Volatile Organic Compounds Emitted by Paint, Ink, and Other Coatings, EPA-450/3-84-019, including updates and revisions.



**SECTION F. Alternative Operation Requirements.**

No Alternative Operations exist for this State Only facility.





**SECTION G. Emission Restriction Summary.**

No emission restrictions listed in this section of the permit.



**SECTION H. Miscellaneous.**

The following activities have been exempted from work practice standards, and testing, monitoring, record keeping, and reporting requirements:

- \* Welding Operations (no PM control devices)
- \* Natural Gas-fired Space Heaters/Burners

-----

The following serves as a description of the Source IDs:

Source IDs 101, 102, and 103 were previously the subject of Plan Approval No. 67-05099.

Source IDs 104 and 105 were previously the subject of Plan Approval No. 67-05099B.



\*\*\*\*\* End of Report \*\*\*\*\*

